

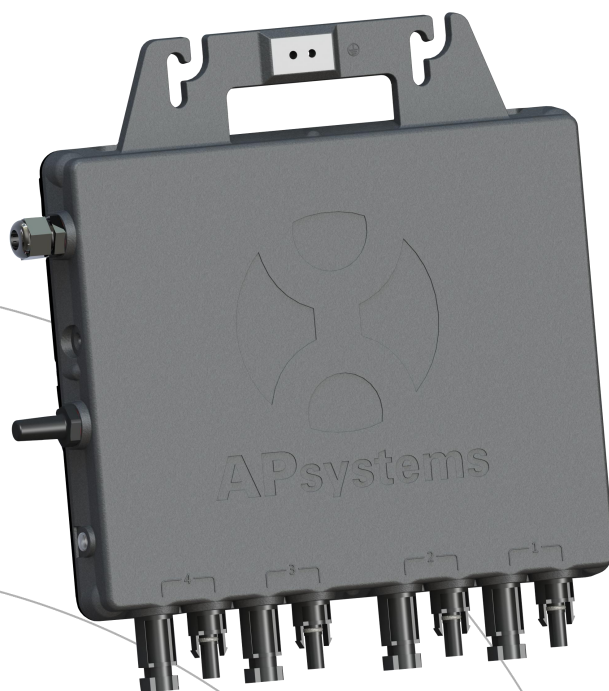

Installation / User Manual

APsystems QS1 Microinverter

Rev 2.3



(For EMEA)

ALTENERGY POWER SYSTEM Inc.
emea.APsystems.com

APsystems

Cypresbaan 7, 2908 LT, Capelle aan den IJssel The Netherlands
Tel: +31-10-2582670 EMAIL: info.emea@APsystems.com

APsystems

Rue des Monts dor ZAC de Follieuses Sud-Les Echets 01700 Miribel, France
TEL: +33-481-65-60-40 EMAIL: info.emea@APsystems.com

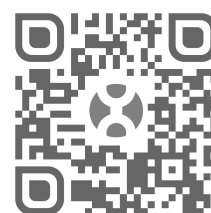

Please scan the QR code to get mobile app and more support to help the installation.

© All Rights Reserved

Table of Contents

1.Important Safety Instructions.....	2
1.1 Safety Instructions.....	2
1.2 Radio Interference Statement.....	3
1.3 Symbols replace words on the equipment, on a display, or in manuals.....	4
2.APsystems Microinverter System Introduction.....	5
3.APsystems Microinverter QS1 Introduction.....	7
4.APsystems Microinverter System Installation.....	8
4.1 Additional Installation components from APsystems.....	8
4.2 Required Parts and Tools from you.....	8
4.3 Installation Procedures.....	9
4.3.1 Step 1 - Verify the grid voltage to match with microinverter rating.....	9
4.3.2 Step 2 - Install the AC bus cable.....	9
4.3.3 Step 3 - Attach the APsystems Microinverters to the racking.....	9
4.3.4 Step 4 - Ground the system.....	10
4.3.5 Step 5 - Connect the APsystems microinverter to AC bus cable.....	10
4.3.6 Step 6 - Install a AC bus protective end cap at the end of AC bus cable.....	10
4.3.7 Step 7 - Connect APsystems Microinverters to the PV Modules.....	11
4.3.8 Step 8 - Complete the APsystems installation map.....	11
4.3.9 Step 9 - Place a Warning Notice.....	12
5.APsystems microinverter system operating instructions.....	13
6.Troubleshooting.....	14
6.1 Status Indications and Error Reporting.....	14
6.1.1 Start up LED.....	14
6.1.2 Operation LED.....	14
6.1.3 GFDI Error.....	14
6.1.4 Other Errors.....	14
6.2 Troubleshooting a non-operating APsystems Microinverter.....	15
6.3 Maintenance.....	15
7.Replace a microinverter.....	16
8.Technical Data.....	17
8.1 QS1 Microinverter Datasheet.....	18
9.Wiring Diagram.....	19
10.QS1 Accessory.....	20
10.1 Wiring Diagram.....	20
10.2 Accessories Summary.....	21

1. Important Safety Instructions

This manual contains important instructions to follow during installation and maintenance of the APsystems Photovoltaic Grid-connected Inverter (Microinverter). To reduce the risk of electrical shock and ensure the safe installation and operation of the APsystems Microinverter, the following symbols appear throughout this document to indicate dangerous conditions and important safety instructions. Specifications are subject to change without notice - please ensure you are using the most recent update found at emea.APsystems.com.

WARNING

This symbol indicates a situation where not following instructions may cause a serious hardware or safety issue and/or put people in danger. Be extremely cautious when performing this task.

NOTICE

This symbol provides important indication to follow in order to optimize microninverters operations. Follow these instructions closely.

1.1 Safety Instructions

- ✓ **Do NOT** disconnect the PV module from the APsystems Microinverter without first disconnecting the AC power.
- ✓ Only qualified professionals should install and/or replace APsystems Microinverters.
- ✓ Perform all electrical installations in accordance with local electrical codes.
- ✓ Before installing or using the APsystems Microinverter, please read all instructions and warning notices in the technical documents and on the APsystems Microinverter system and the solar-array.
- ✓ Be aware that the case of the APsystems Microinverter is the heat sink and can reach a temperature of 80°C. To reduce risk of burns, do not touch the case of the Microinverter.
- ✓ **Do NOT** attempt to repair the APsystems Microinverter. If it fails, contact APsystems Customer Support to obtain an RMA number and start the replacement process. Damaging or opening the APsystems Microinverter will void the warranty.
- ✓ Caution!
If the photovoltaic module is exposed to light, it provides a DC output voltage.
- ✓ Please install AC breakers on the AC side of the inverter.

1.Important Safety Instructions

1.2 Radio Interference Statement

CE EMC Compliance: The equipment can comply with CE EMC, which are designed to protect against harmful interference in a residential installation. The equipment could radiate radio frequency energy and this might cause harmful interference to radio communications if instructions are not followed when installing and using the equipment. But there is no guarantee that interference will not occur in a particular installation. If this equipment causes harmful interference to radio or television reception, the following measures might resolve the issues:

- A) Relocate the receiving antenna and keep it well away from the equipment.







- B) Consult the dealer or an experienced radio / TV technical for help.

Changes or modifications not expressly approved by the party responsible for compliance may void the user's authority to operate the equipment.

.

1. Important Safety Instructions

1.3 Symbols replace words on the equipment, on a display, or in manuals

 APsystems Trademark.	
	Caution, risk of electric shock.
	Caution, hot surface.
	Symbol for the marking of electrical and electronics devices according to Directive 2002/96/EC. Indicates that the device, accessories and the packaging must not be disposed as unsorted municipal waste and must be collected separately at the end of the usage. Please follow Local Ordinances or Regulations for disposal or contact an authorized representative of the manufacturer for information concerning the decommissioning of equipment.
	CE mark is attached to the solar inverter to verify that the unit follows the provisions of the European Low Voltage and EMC Directives.
	Refer to the operating instructions.
Qualified personnel	Person adequately advised or supervised by an electrically skilled person to enable him or her to perceive risks and to avoid hazards which electricity can create. For the purpose of the safety information of this manual, a "qualified person" is someone who is familiar with requirements for safety, electrical system and EMC and is authorized to energize, ground, and tag equipment, systems, and circuits in accordance with established safety procedures. The inverter and complete system may only be commissioned and operated by qualified personnel.

2.APsystems Microinverter System Introduction

The APsystems Microinverter is used in utility-interactive grid-tied applications, comprised of three key elements:

- APsystems Microinverter
- APsystems Energy Communication Unit (ECU)
- APsystems Energy Monitor and Analysis (EMA) web-based monitoring and analysis system

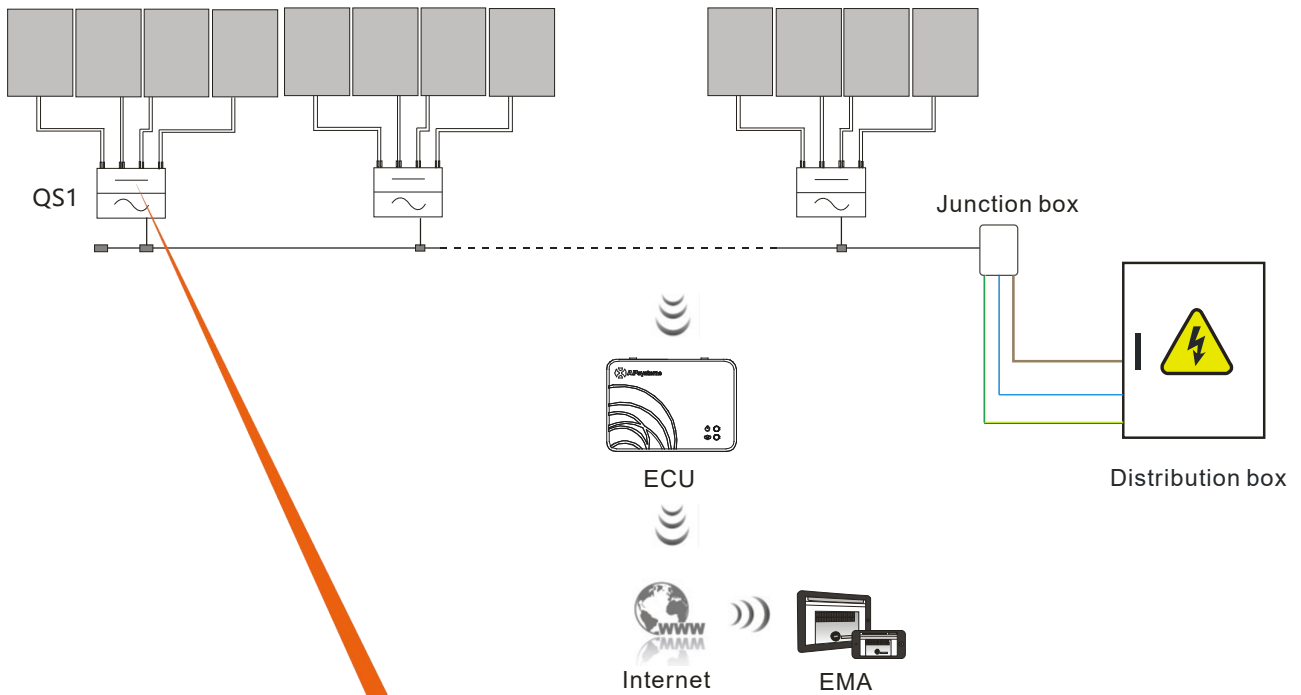
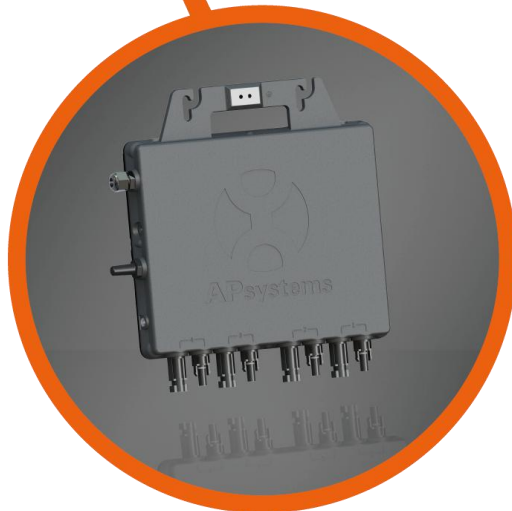

Figure 1



2. APsystems Microinverter System Introduction

This integrated system improves safety; maximizes solar energy harvest; increases system reliability, and simplifies solar system design, installation, maintenance, and management.

APsystems Microinverters maximize PV energy production

Each PV module has individual Maximum Peak Power Tracking (MPPT) controls, which ensures that the maximum power is produced to the utility grid regardless of the performance of the other PV modules in the array. When PV modules in the array are affected by shade, dust, orientation, or any situation in which one module underperforms compared with the other units, the APsystems Microinverter ensures top performance from the array by maximizing the performance of each module within the array.

More reliable than centralized or string inverters

The distributed APsystems Microinverter system ensures that no single point of system failure exists across the PV system. APsystems Microinverters are designed to operate at full power at ambient outdoor temperatures of up to 149°F (65°C). The inverter case is designed for outdoor installation and complies with the IP67 environmental enclosure rating.

Simple to install

You can install individual PV modules in any combination of module quantity, orientation, type, and power rate.

Smart system performance monitoring and analysis

The APsystems Energy Communication Unit (ECU) is installed by simply plugging it into any wall outlet and providing an Ethernet or Wi-Fi connection to a broadband router or modem. After installing and configuring the ECU, the full network of APsystems Microinverters automatically reports to the APsystems Energy Monitor and Analysis (EMA) web server. The EMA software displays performance trends, informs you of abnormal events, and controls system shutdown when it is needed. (See ECU manual for instructions.)

3.APsystems Microinverter QS1 Introduction

The APsystems QS1 Microinverter connect to single phase grid and can also be configured for 3-phase grid, and operates with most 60 and 72 cell PV modules. Contact APsystems Customer Support for checking compatibility. For more information, please see the Technical Data page (p.18) of this manual.

Model Number	AC grid	PV Module	Module Connector
QS1	50Hz/230V	60,72Cell	MC-4 type

4. APsystems Microinverter System Installation

A PV system using APsystems Microinverters is simple to install. Each Microinverter easily mounts on the PV racking, directly beneath the PV module(s). Low voltage DC wires connect from the PV module directly to the Microinverter, eliminating the risk of high DC voltage. Installation **MUST** comply with local regulations and technical rules.

WARNING

- ① Perform all electrical installations in accordance with local electrical codes.
- ② Be aware that only qualified professionals should install and/or replace APsystems Microinverters.
- ③ Before installing or using an APsystems Microinverter, please read all instructions and warnings in the technical documents and on the APsystems Microinverter system itself as well as on the PV array.
- ④ Be aware that installation of this equipment includes the risk of electric shock.
- ⑤ Do not touch any live parts in the system, including the PV array, when the system has been connected to the electrical grid.

NOTICE

Strongly recommend to install Surge protection Devices in the dedicated meter box.

4.1 Additional Installation components from APsystems

- Bus Cable End Cap (sold separately)
- Bus Cable Y-CONN Cap (sold separately)
- Bus Cable Unlock Tool (sold separately)

4.2 Required Parts and Tools from you

In addition to your PV array and its associated hardware, you will need the following items:

- An AC connection junction box
- Mounting hardware suitable for module racking
- Accessories and tools to fix the mounting system

4.APsystems Microinverter System Installation

4.3 Installation Procedures

4.3.1 Step 1 - Verify the grid voltage to match with microinverter rating

4.3.2 Step 2 - Install the AC bus cable

- The AC bus is installed at a position matching the microinverter location.
- One end of the AC bus is connected to the mains via the junction box.
- Wire the conductors of the AC bus: L - BROWN; N - BLUE; PE - YELLOW GREEN.**

⚠ WARNING

Wiring colour code can be different according to local regulations, check all the wires of the installation before connecting to the AC bus to be sure they match. Wrong cabling can damage irreparably the microinverters, such an issue is not covered by the warranty.

⚠ WARNING

Forbidden to hand carry the inverter through AC cable.

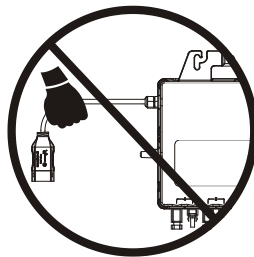

4.3.3 Step 3 - Attach the APsystems Microinverters to the racking

- Mark the location of the microinverter on the rack, taking into account the position of the PV module junction box or any other obstructions.
- Mount one microinverter at each of these locations using hardware recommended by your module racking vendor. When installing the microinverter, make sure the grounding washer is facing the racking.

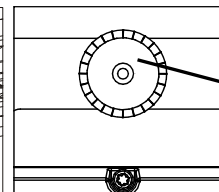
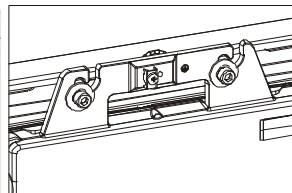
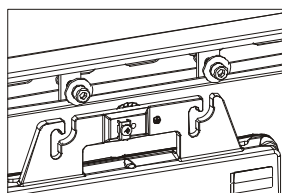
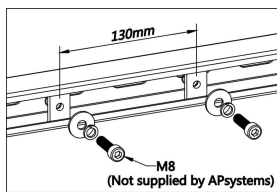

grounding washer
Warning injure hand

Figure 2

⚠ WARNING

Prior to installing any of the microinverters, verify that the utility Voltage at the point of common connection matches the voltage rating on microinverter label.

⚠ WARNING

Do not place the inverters (including DC and AC connectors) with direct exposure to the sun, rain, or snow. Allow a minimum of 2 cm of space around the microinverter case for heat dissipation and proper air flow. The racking used to fix the microinverter should be reliably grounded.

4. APsystems Microinverter System Installation

4.3.4 Step 4 - Ground the system

- There already has earth wire inside the AC cable, thus the grounding work could be done directly by it.
- For those areas that have special requirements, the external grounding work could be done by grounding brackets.

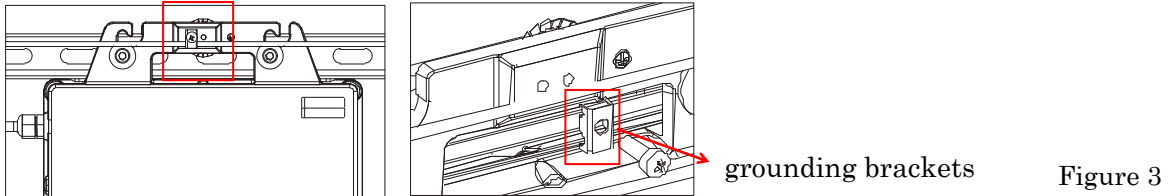

Figure 3

4.3.5 Step 5 - Connect the APsystems microinverter to AC bus cable

Push the microinverter AC connector into the trunk cable connector until you hear a "click". Try to remove it to check that it is properly locked.

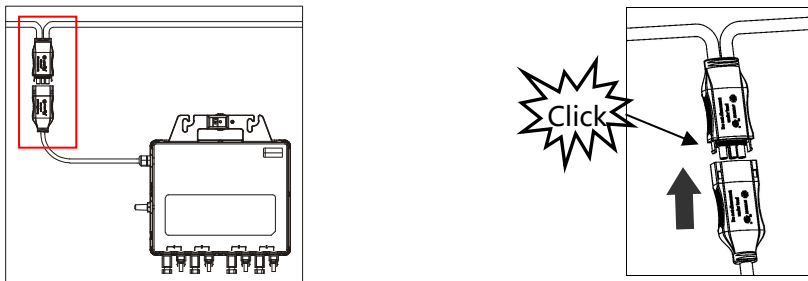

Figure 4

Best Practice: Use the Bus Cable Unlock Tool of AC Bus to split the connectors.

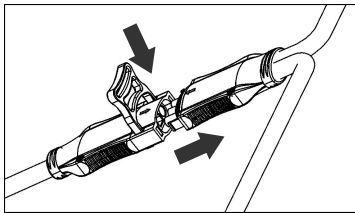
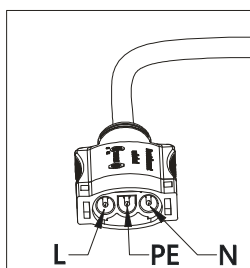

Figure 5

AC connector interface as follows.



Cover any unused connectors with Bus Cable Y-CONN Cap to protect the connectors.

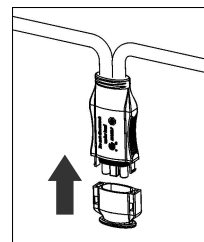
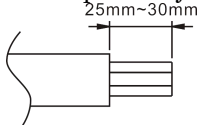

Figure 6

4.3.6 Step 6 - Install a AC bus protective end cap at the end of AC bus cable

- Strip cable jacket.



- Insert the cable end into the seal.

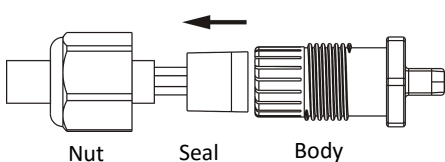

- Insert the wires into the cable clamps.

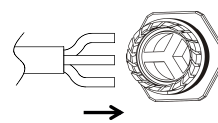

- Rotate the nut with 3.3N m until the latching mechanism meets the base.

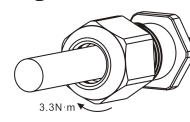

Figure 7

4. APsystems Microinverter System Installation

4.3.7 Step 7 - Connect APsystems Microinverters to the PV Modules

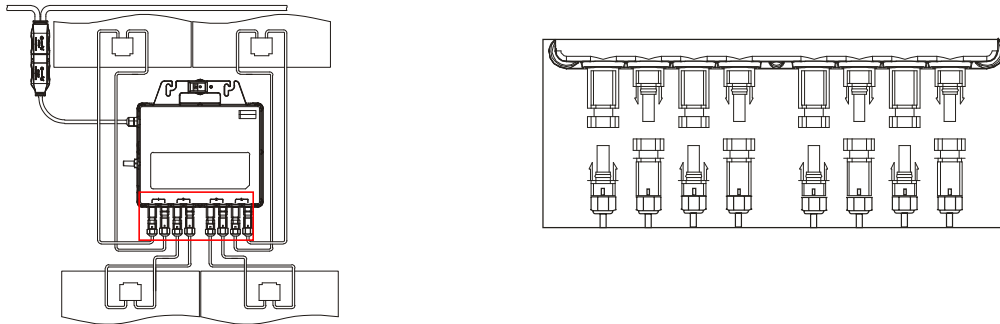

Figure 8

NOTICE

When connecting the 1st module, the LED of the microinverter must flash three times in green. This happens as soon as the cables are plugged in, to show that the microinverter is working properly. This control function starts and ends within 5 seconds after the device is connected, so pay particular attention to these LEDs when connecting the DC cables.

WARNING

Double check to make sure all of the AC and DC wiring has been correctly installed. Ensure that none of the AC and/or DC wires are pinched or damaged. Make sure that all of the junction boxes are properly closed.

4.3.8 Step 8 - Complete the APsystems installation map

Fill in the APsystems Registration Cards, which provide system information and the installation map. Feel free to provide your own layout if a larger or more intricate installation map is required. The layout map provided is designed to accommodate labels in vertical or horizontal orientation to meet all the field PV connections.

- Each APsystems Microinverter has removable serial number labels.
- Peel labels off, affix one to the respective location on the APsystems installation map, and fill in 1, 2, 3 and 4 in the label below, according to the layout on the roof.
- The other one serial number label, posted on the solar module frame is easy to view the position.

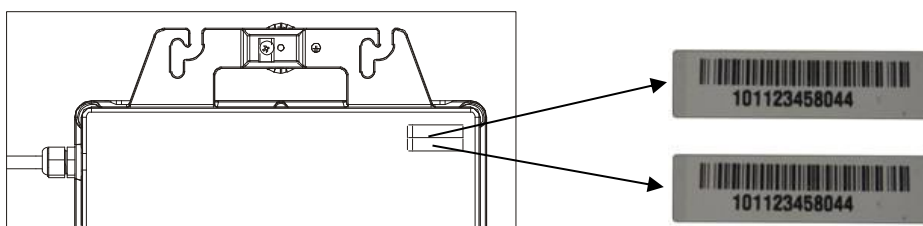





Figure 9

4.APsystems Microinverter System Installation

APsystems Microinverter & Energy Communication Unit Warranty Card

The APsystems Installation Map is a diagram of the physical location of each microinverter in your PV installation. Each APsystems microinverter has a removable serial number label located on the mounting plate. Peel the label and affix it to the respective location on the APsystems installation map.

Installation Map Template

1	2	3	4	5	6	7	8	9	10	11	12	13	14	15	16	17	18	19	20	21	22	
																						
																						



NOTICE

- ①. The layout of the microinverters serial numbers on the warranty card is only suitable for general arrangement.
- ②. Warranty card is located in the last page of the Appendix of this manual.
- ③. You can use Scanning Gun or mobile phone to scan the serial numbers on the map when setting the ECU (see ECU manual).

4.3.9 Step 9 - Place a Warning Notice

A warning notice must be placed in such a way that anyone with access to live parts is warned in advance of the need to switch off the parts. It is imperative to verify that the power supply, measurement circuits (sense lines) and other parts are not isolated from the network when the interface protection switch is open.

As a minimum, warning labels shall be placed:

- On the switchboard (DNO panel and consumer unit) that has the micro-generator connected to it;
- On all switchboards in between the consumer unit and the micro-generator itself;
- On, or in the micro-generator itself;
- At all points of isolation for the micro-generator.

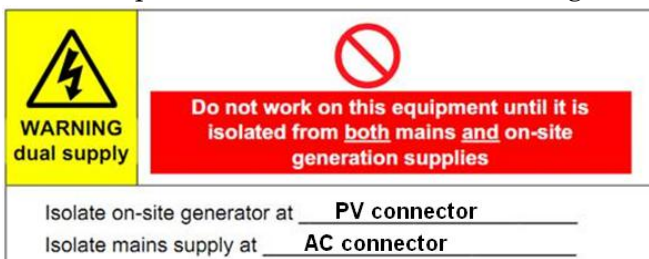

5. APsystems microinverter system operating instructions

To operate the APsystems microinverter PV system:

1. Turn ON the AC circuit breaker on each microinverter AC branch circuit.
2. Turn ON the main utility-grid AC circuit breaker. Your system will start producing power after few minutes waiting time.
3. The LED should blink green every 2 seconds. This means that the operation is normal.
4. Connect the ECU communication gateway (optional) and follow the instructions in the manual. Once the ECU is plugged in and set up, it recognizes the microinverters, then the LED flashes green every 10 seconds.
5. The APsystems Microinverters will start to send performance data over ZigBee to the ECU. The time required for all the Microinverters in the system to report to the ECU will vary with the number of Microinverters in the system. You can verify proper operation of the APsystems Microinverters via the ECU. See the ECU Installation and Operation Manual for more information.

6.Troubleshooting

Qualified personnel can use the following troubleshooting steps if the PV system does not operate correctly:

6.1 Status Indications and Error Reporting

6.1.1 Start up LED

When the 1st PV module is connected to the microinverter, the LED flashes once red, then 3 times green quickly. This indicates correct operation.

6.1.2 Operation LED

Flashing Slow Green (10 sec. gap) - Producing power and communicating with ECU

Flashing Fast Green (2 sec. gap) - Producing power and not communicating with ECU over 60mins

Flashing Red - Not producing power

Steady Red - Ground fault protection

6.1.3 GFDI Error

A solid red LED indicates the Microinverter has detected a Ground Fault in the PV system(GFDI alarm). Until the GFDI alarm has been cleared, the LED will remain red and the ECU will keep reporting the fault.After the ground fault is fixed, follow the instructions in the ECU Installation and Operation Manual to clear this GFDI error reporting.

6.1.4 Other Errors

All other faults are reported to the ECU. Refer to the ECU Installation and Operation Manual for a list of additional faults and troubleshooting procedures.

WARNING

Only qualified personnel should directly handle the APsystems microinverter.

WARNING

- ①. Never disconnect the DC wire connectors under load. Ensure that no current is flowing in the DC wires prior to disconnecting.
- ②. Always disconnect AC power before disconnecting the PV module wires from the APsystems Microinverter.
- ③. The APsystems microinverter is powered by DC current of the PV module. After reconnecting DC, please check that the LED behaves as in 6.1.1 above.

6.Troubleshooting

6.2 Troubleshooting a non-operating APsystems Microinverter

There are two possible overall areas of trouble:

- A. The Microinverter itself may be having problems.
- B. The Microinverter itself is working fine but it is having trouble communicating with the ECU. The items below refer to Microinverter issues, not communication issues (addressed in the ECU manual).

A quick way to tell whether the issue is the Microinverter or communication problem with the ECU:

1. **Diagnosing from the Microinverter:** A red light – either blinking or solid on the Microinverter, or no light at all. No light, or a red light, means it is definitely a Microinverter problem.
2. **Diagnosing from the ECU:**
 - a. **No-Data-Display:** This is probably a communication issue- not a Microinverter problem.
 - b. **Problems with erratic display:** Data is displayed for some period and then no data is displayed: most likely a communication issue.
 - c. **0 watts, or 2 watts:** Possibly a Microinverter problem
 - d. **Erratic data display** that is not coordinating with data displays from other units: most likely a Microinverter problem.

To troubleshoot a non-operating APsystems Microinverter, Follow the steps below in order to:

1. Verify the utility voltage and frequency are within ranges shown in the Technical Data section of this manual.
2. Check the connection to the utility grid. Verify utility power is present at the inverter in question by removing AC, then DC power. **Never disconnect the DC wires while the microinverter is producing power.** Reconnect the 1st module and check that the LED flashes green 3 times.
3. Check the AC branch circuit interconnection between all the microinverters. Verify each inverter is energized by the utility grid as described in the previous step.
4. Make sure that any AC breaker are functioning properly and are closed.
5. Check the DC connections between the microinverter and the PV module.
6. Verify the PV module DC voltage is within the allowable range shown in the Technical Data of this manual.
7. If the problem persists, please call APsystems Customer Support.

WARNING

Do not attempt to repair the APsystems Microinverter. In the event of failure of the troubleshooting methods and after validation of the fault by the APsystems technical service, please return the defective microinverter to your distributor for replacement.

6.3 Maintenance

No need to Maintenance.

7. Replace a microinverter

Follow the procedure to replace a failed APsystems Microinverter

- A. Disconnect the APsystems Microinverter from the PV Module, in the order shown below:
 - 1. Disconnect the AC by turning off the branch circuit breaker.
 - 2. Disconnect the inverter AC connector from the AC Bus.
 - 3. Disconnect the PV module DC wire connectors from the microinverter.
 - 4. Remove the Microinverter from the PV array racking.

- B. Install a replacement Microinverter to the rack. Remember to observe the flashing LED light as soon as the new Microinverter is plugged into the DC cables.

- C. Connect the AC cable of the replacement Microinverter to the AC bus.

- D. Close the branch circuit breaker, and verify operation of the replacement Microinverter.

8. Technical Data

WARNING

- ①. Be sure to verify the voltage and current specifications of your PV module. It should match with those of the Microinverter. Please refer to the datasheet or usermanual which can be download from APsystems website emea.APsystems.com.
- ②. You must match the DC operating voltage range of the PV module with the allowable input voltage range of the APsystems Microinverter.
- ③. The maximum open circuit voltage of the PV module must not exceed the specified maximum input voltage of the APsystems.

8.1 QS1 Microinverter Datasheet

Region	EMEA
Model	QS1-EU
Input Data (DC)	
Recommended PV Module Power (STC) Range	250Wp-440Wp+
MPPT Voltage Range	22V-48V
Operation Voltage Range	16V-55V
Maximum Input Voltage	60V
Startup Voltage	20V
Maximum Input Current	12A×4
Output Data (AC)	
Maximum Continuous Output Power	1200W
Peak Output Power	1250W
Nominal Output Voltage/Range	230V/184-253V
Adjustable Output Voltage Range	160V-278V
Nominal Output Current	5.22A
Max output fault current	36A
Maximum output overcurrent protection	10A
Maximum Units Per Branch	3units per 20A AC breaker/4units per 25A AC breaker
Nominal Output Frequency/Range	50Hz/48-51Hz
Adjustable Output Frequency Range	45.1Hz-54.9Hz
Power Factor(Adjustable)	0.8 leading...0.8 lagging
Total Harmonic Distortion	<3%
Zigbee RF Frequency Range	2405MHz to 2480MHz
Maximum RF transmit power	20dBm
Efficiency	
Peak Efficiency	96.5%
Nominal MPPT Efficiency	99.5%
Night Power Consumption	30mW
Mechanical Data	
Operating Ambient Temperature Range	-40°C to +65°C
Storage Temperature Range	-40°C to +85°C
Dimensions (W x H x D)	281mm × 231mm × 41.3mm
Weight	4.5kg
AC BUS Maximum Current	20A(2.5mm ²)
Enclosure Environmental Rating	Outdoor - IP67
Pollution Degree Classification	PD3
Cooling	Natural Convection - No Fans
Operate relative humidity range	4%~100%
Maximum altitude	<2000m
Overtoltage Category	OVC II For PV Input Circuit, OVC III For Mains Circuit
Features & Compliance	
Communication	Wireless
Transformer Design	High Frequency Transformers, Galvanically Isolated
Monitoring	Via EMA* Online Portal
Warranty	10 Years Standard ; 20 Years Optional
Certificate&Compliance	
Safety And EMC Compliance	EN 62109-1;EN 62109-2;EN 61000-6-1;EN 61000-6-2; EN 61000-6-3;EN 61000-6-4
Grid Connection Compliance	VDE0126-1-1/A1 VFR2019,ERDF-NOI-RES_13E,EN 50549-1,UTE C15-712-1

*APsystems online Energy Management Analysis (EMA) platform

Specifications subject to change without notice - please ensure you are using the most recent update found at www.APsistemas.com

2020/04/13 Rev2.3

9.Wiring Diagram

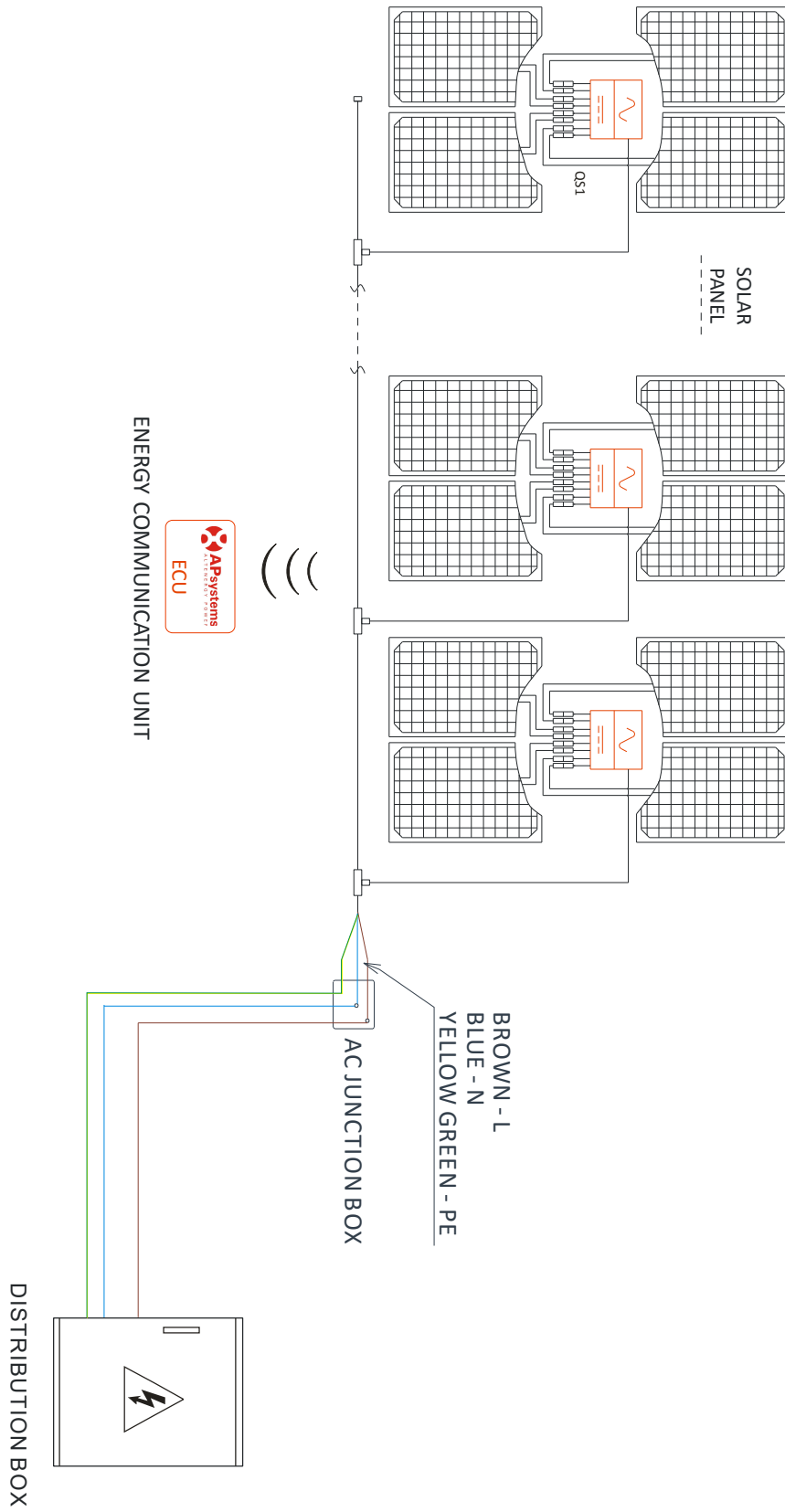
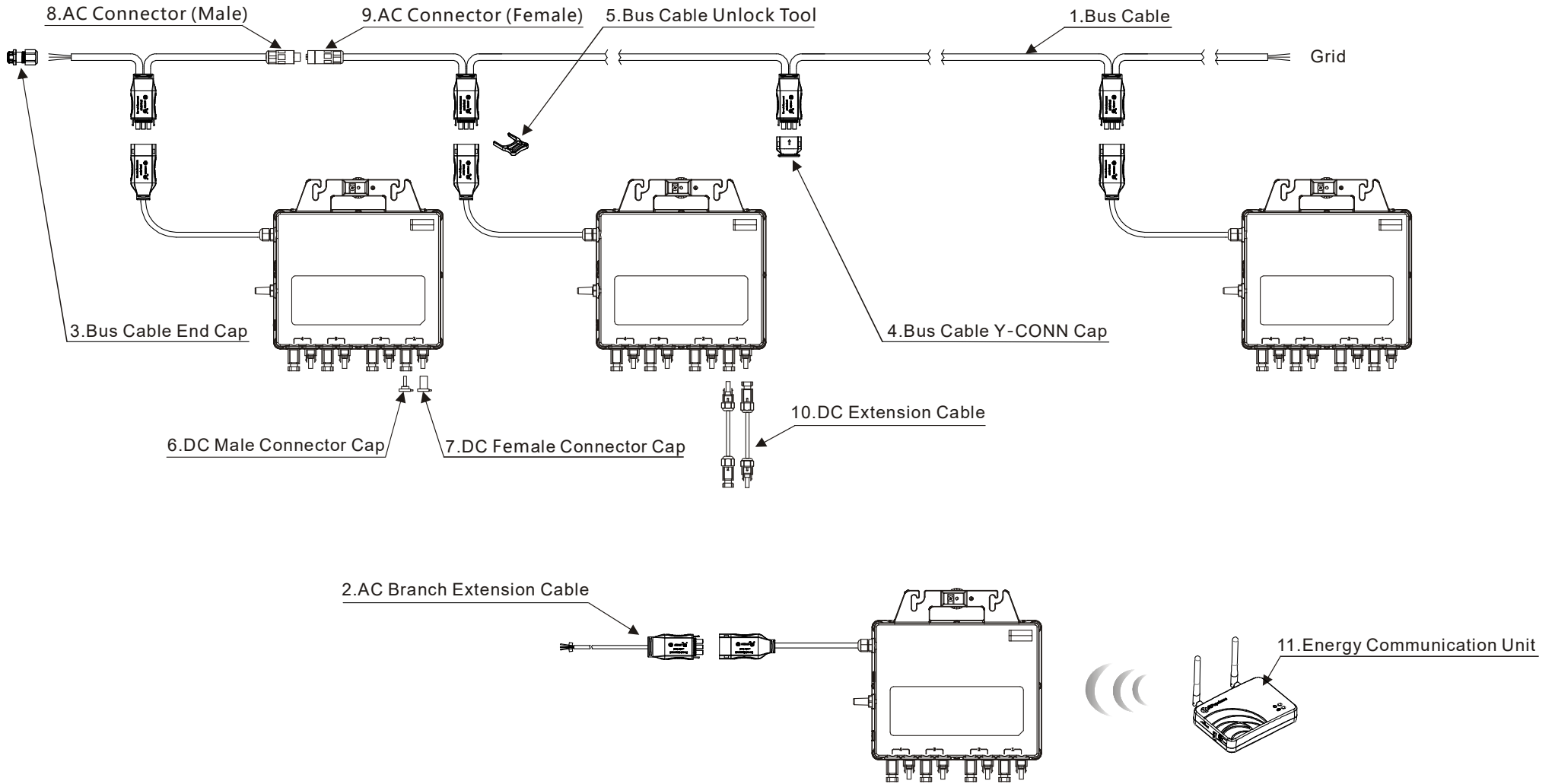

Figure10

10.QS1 Accessory

10.1 Wiring Diagram



10.2 Accessories Summary

Accessories				
Category	Part NO.	Name	Pic	
1	Bus Cable	2322304903	Y3 Bus Cable(2.5mm ² ,H07RN-F,2m,BN-BU-YL/GN)	
		2322404903	Y3 Bus Cable(2.5mm ² ,H07RN-F,4m,BN-BU-YL/GN)	
2	AC Branch Extension Cable (On demand)	2334076132	Y3 Br. Ext-Cable(2.5mm ² ,H07RN-F,1m,BN-BU-YL/GN)	
3	Bus Cable End Cap	2060700007	3/4-wire Bus Cable End Cap	
4	Bus Cable Y-CONN Cap	2061702007	Bus Cable Y-CONN Cap	
5	Bus Cable Unlock Tool	2352000001	Y Bus Cable Unlock Tool	
6	DC Male Connector Cap	2060401006	DC Male Connector Cap (MC4)	
7	DC Female Connector Cap	2060402006	DC Female Connector Cap (MC4)	
8	AC Connector (Male)	2300531032	25A AC Male Connector (EN,3-wire)	
9	AC Connector (Female)	2300532032	25A AC Female Connector (EN,3-wire)	
10	DC Extension Cable (Optional)	2310310274	1m DC Extension Cable (MC4)	
11	Energy Communication Unit	—	ECU-R or ECU-C	

APsystems Microinverter & Energy Communication Unit Warranty Card

The APlsystems Installation Map is a diagram of the physical location of each microinverter in your PV installation. Each APlsystems microinverter has a removable serial number label located on the mounting plate. Peel the label and affix it to the respective location on the APlsystems installation map.

Installation Map Template

1	2	3	4	5	6	7	8	9	10	11	12	13	14	15	16	17	18	19	20	21	22	